

NEW KEYS COLLECTION

2023
OCTOBER

NR.
10



NETWORK WITH US





2023 NEW KEYS COLLECTION

NEW KEYS



Silca key blanks are compatible with third party manufacturers' cylinders specified here below:

ABUS*

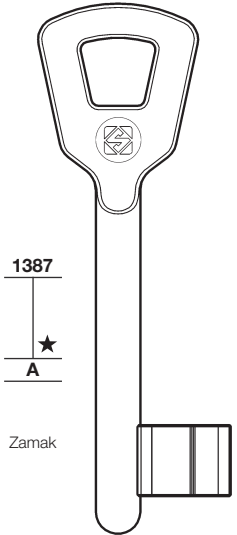

6AB-A2



6AB-A3



6AB-A4



6AB-A5



6AB-A6



6AB-A7



6AB-A1



6AB-A8



6AB-A9



6AB-A10



Box of 25 for all ref.

ABUS*

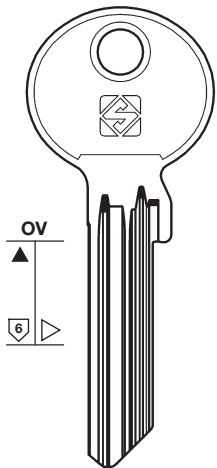

AB127R-2



Box of 50

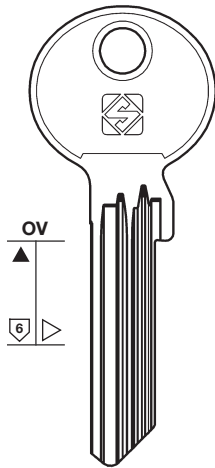

AB127R-3



Box of 50

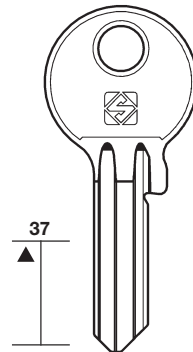

AB126



Box of 100

ABUS* (DE)

(*) This is a trademark of a third party not affiliated nor linked with Silca S.p.A. or the dormakaba Group. Silca S.p.A. and dormakaba Group do not own any intellectual property right nor have been granted any license with regard to such trademark, which is hereby used only to indicate the intended purpose of Silca's products.



2023 NEW KEYS COLLECTION

NEW KEYS



Silca key blanks are compatible with third party manufacturers' cylinders specified here below:

ABUS*			ANKERSLOT*
P508	OV	OV	1320
AB125RCP	AB36X	AB36RX	AKR27
8 052782 029887	8 052782 032856	8 052782 032849	8 052782 033914
Box of 25	Box of 50	Box of 50	Box of 50
ASSA*	AVOCET*		
745	P517	P517	
ASS184R	AVC3RP-1	AVC3RP-2	
8 052782 033266	8 052782 034805	8 052782 034812	
Box of 50	Box of 25	Box of 25	

- ABUS* (DE)
- ANKERSLOT* (NL)
- ASSA* (SE)
- AVOCET* (GB)

(*) This is a trademark of a third party not affiliated nor linked with Silca S.p.A. or the dormakaba Group. Silca S.p.A. and dormakaba Group do not own any intellectual property right nor have been granted any license with regard to such trademark, which is hereby used only to indicate the intended purpose of Silca's products.

Silca key blanks are compatible with third party manufacturers' cylinders specified here below:

AVOCET*			AVOCET* ^(GB) BAB* ^(DE) BASI* ^(FI)
 P517 S1282 WA 400001 WE 411502 14,9 mm AVC3RP-3	 P517 S1282 WA 400001 WE 411502 10,15 mm AVC3RP-4	 P517 S1282 WA 400001 WE 411502 5,4 mm AVC3RP-5	
 8 052782 034829 Box of 25	 8 052782 034836 Box of 25	 8 052782 034843 Box of 25	
BAB*		BASI*	
 897 BAB35-PS	 897 BAB35R-PS	 1823 BAI28	
 8 003737 863582 Box of 50	 8 003737 863599 Box of 50	 8 052782 028484 Box of 50	

(*) This is a trademark of a third party not affiliated nor linked with Silca S.p.A. or the dormakaba Group. Silca S.p.A. and dormakaba Group do not own any intellectual property right nor have been granted any license with regard to such trademark, which is hereby used only to indicate the intended purpose of Silca's products.











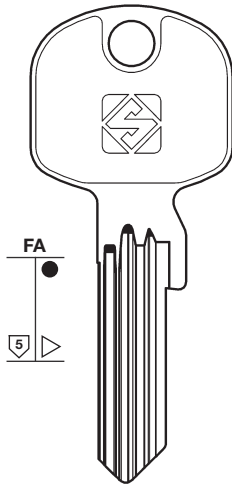
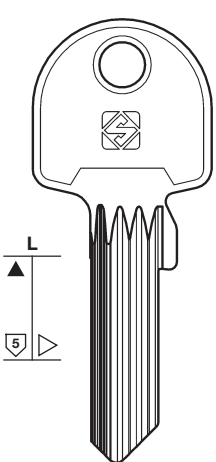
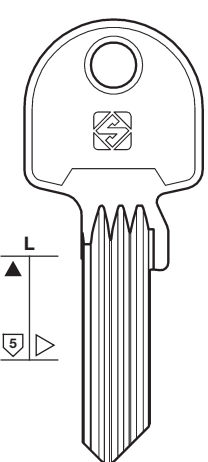

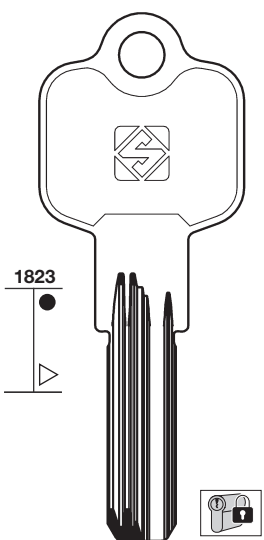
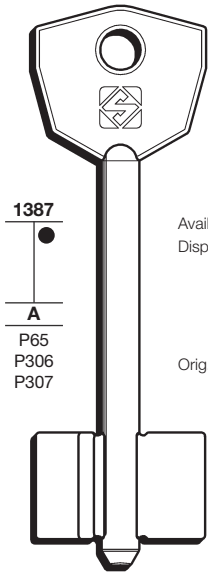
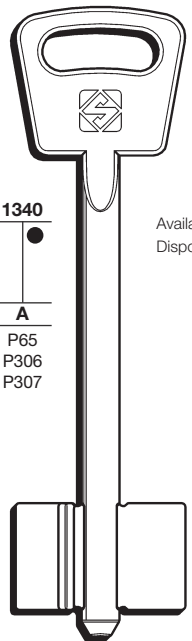

2023 NEW KEYS COLLECTION

NEW KEYS



Silca key blanks are compatible with third party manufacturers' cylinders specified here below:

BASI*			BASI* ^(FI)	
			BODA*^(FI)	
			BODA*^(FI)	
BAI30	BAI31XL	BAI31RXL		
				
Box of 50	Box of 50	Box of 50		
BASI*	BODA*			
				
				
BAI29R	5BDA1	5BDA7		
				
Box of 50	Box of 25	Box of 25		
	Available in brass Disponibile in ottone	Available in brass Disponibile in ottone		
	Orig. code: 428			
	P65 P306 P307	P65 P306 P307		
	1387	1340		
	A	A		

(* This is a trademark of a third party not affiliated nor linked with Silca S.p.A. or the dormakaba Group. Silca S.p.A. and dormakaba Group do not own any intellectual property right nor have been granted any license with regard to such trademark, which is hereby used only to indicate the intended purpose of Silca's products.



2023 NEW KEYS COLLECTION

NEW KEYS



Silca key blanks are compatible with third party manufacturers' cylinders specified here below:

BKS*

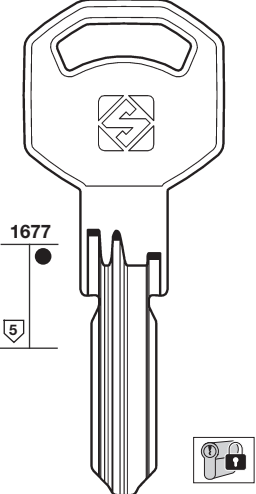

BK57R



Box of 50

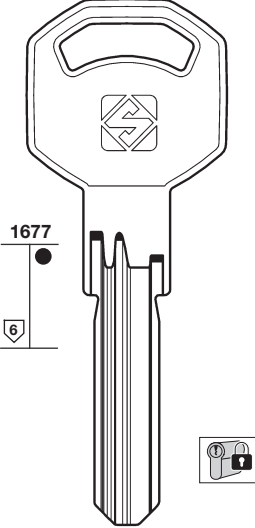

BK54R



Box of 50

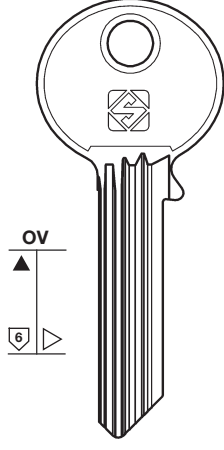

BK6-PS

1000 Serie



Box of 50

BURG*

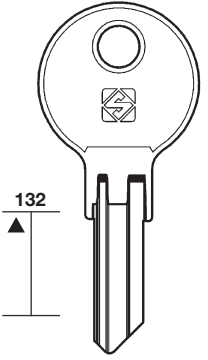

BUR70



Box of 100

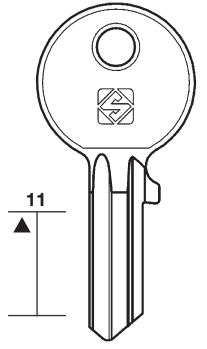

BUR71



Box of 100

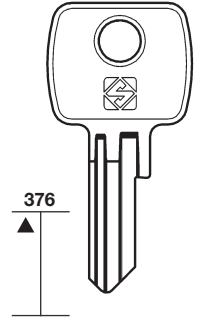

BUR72



Box of 100

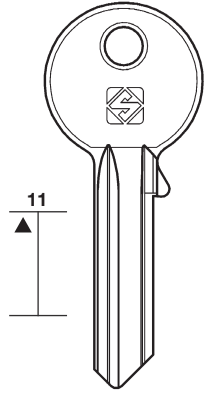

BUR73



Box of 100

BKS* (DE)

BURG* (DE)

(*) This is a trademark of a third party not affiliated nor linked with Silca S.p.A. or the dormakaba Group. Silca S.p.A. and dormakaba Group do not own any intellectual property right nor have been granted any license with regard to such trademark, which is hereby used only to indicate the intended purpose of Silca's products.











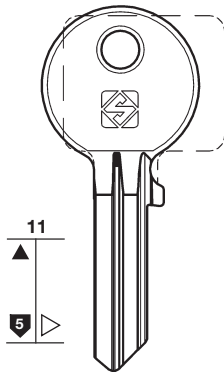

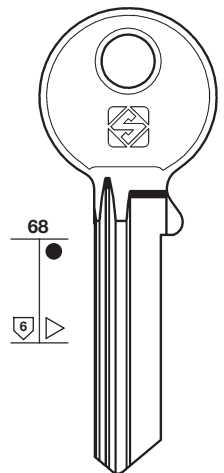

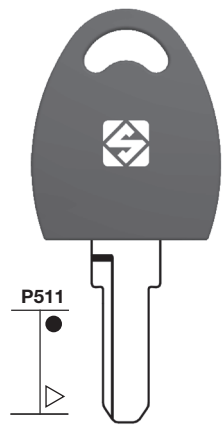

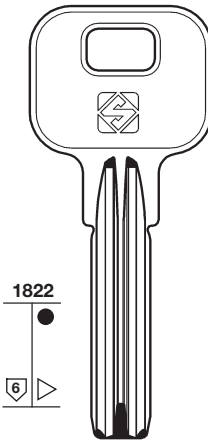
2023 NEW KEYS COLLECTION

NEW KEYS

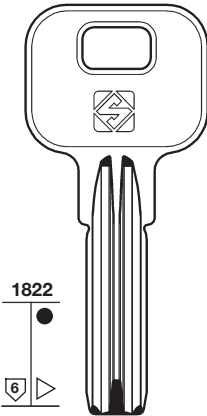

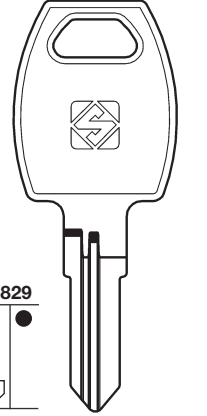
Silca key blanks are compatible with third party manufacturers' cylinders specified here below:

BKS*	CES*	CINA*	
 <p>11 5</p>  <p>BUR29R</p>  <p>8 052782 030128</p> <p>Box of 50</p>	 <p>68 6</p>  <p>CE14RPS</p>  <p>8 052782 032863</p> <p>Box of 50</p>	 <p>P511</p>  <p>RC26RP</p>  <p>8 052782 029894</p> <p>Box of 25</p>	<p>BKS* (DE)</p> <hr/> <p>CES* (DE)</p> <hr/> <p>CINA* (CN)</p>
CINA*			
 <p>1822 6</p>  <p>RC29</p>  <p>8 052782 027746</p> <p>Box of 50</p>	<p>Lock Systems: MTW (6P) MTW (7P)</p>   <p>1822 6</p>  <p>RC30</p>  <p>8 052782 027753</p> <p>Box of 50</p>	 <p>1829 6</p>  <p>RC28R</p>  <p>8 052782 026695</p> <p>Box of 50</p>	<p>(*) This is a trademark of a third party not affiliated nor linked with Silca S.p.A. or the dormakaba Group. Silca S.p.A. and dormakaba Group do not own any intellectual property right nor have been granted any license with regard to such trademark, which is hereby used only to indicate the intended purpose of Silca's products.</p>



2023 NEW KEYS COLLECTION

NEW KEYS



Silca key blanks are compatible with third party manufacturers' cylinders specified here below:

CISA*				CISA* (IT)
				CLARK F.L.* (US)
1456 6+6	1456 5	1456 5	1456 5	CORBIN* (IT)
CS186	CS187	CS188	CS189	
8 052782 033921	8 052782 034386	8 052782 034379	8 052782 034362	
Box of 50	Box of 50	Box of 50	Box of 50	
CISA*	CLARK F.L.*	CORBIN*		
P468 6	1824	1434 6		
CS185AP "Astral" System	CFT1	CB97SMD		
8 052782 031163	8 052782 029702	8 052782 032917		
Box of 25	Box of 50	Box of 50		
		Lock Systems: Eurostar, Corbin Two, Ifam F11SX		

(*) This is a trademark of a third party not affiliated nor linked with Silca S.p.A. or the dormakaba Group. Silca S.p.A. and dormakaba Group do not own any intellectual property right nor have been granted any license with regard to such trademark, which is hereby used only to indicate the intended purpose of Silca's products.



2023 NEW KEYS COLLECTION

NEW KEYS



Silca key blanks are compatible with third party manufacturers' cylinders specified here below:

DOM*

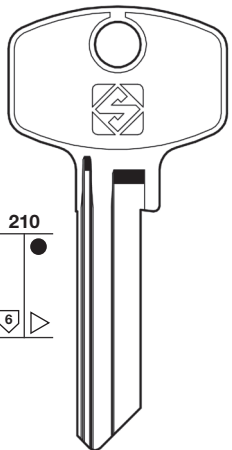

210
6



DM100



8 003736 785793
Box of 50

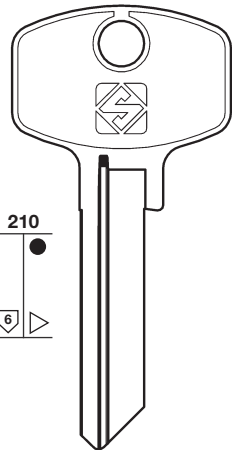

210
6



DM100R



8 003736 785861
Box of 50

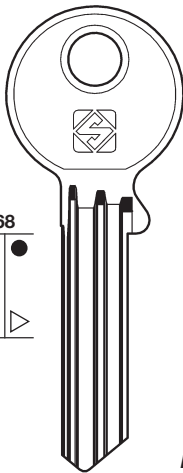

68
6



DM126



8 003737 834940
Box of 50

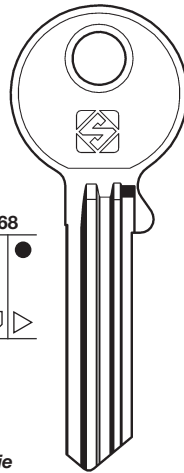

68
6



DM126R



8 003736 495319
Box of 100

PP1024 Serie

DOM*

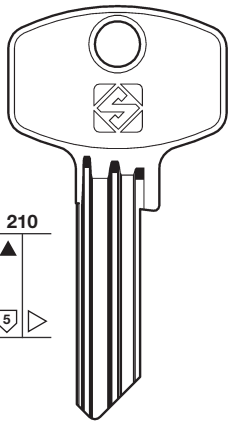

210
5



DM143



8 003737 852609
Box of 50

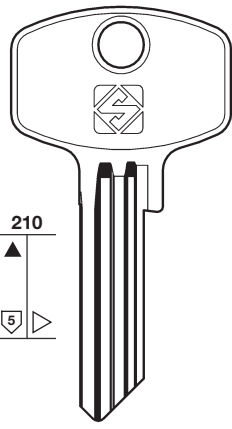

210
5



DM143R



8 003737 835176
Box of 50

PP1024 Serie

ELBOR*

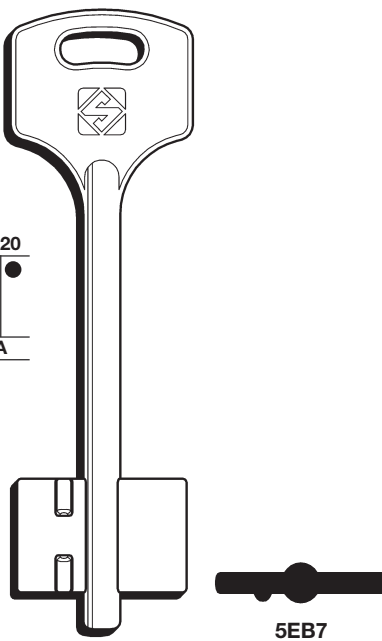

1420
A



5EB7



8 052782 037035
Box of 25

DOM* (DE)

ELBOR* (RU)

(*) This is a trademark of a third party not affiliated nor linked with Silca S.p.A. or the dormakaba Group. Silca S.p.A. and dormakaba Group do not own any intellectual property right nor have been granted any license with regard to such trademark, which is hereby used only to indicate the intended purpose of Silca's products.











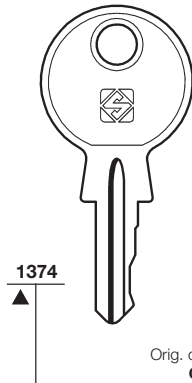

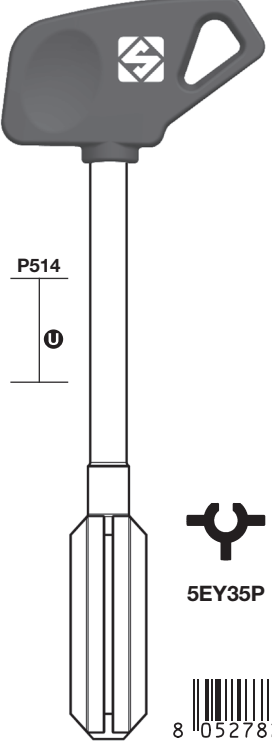

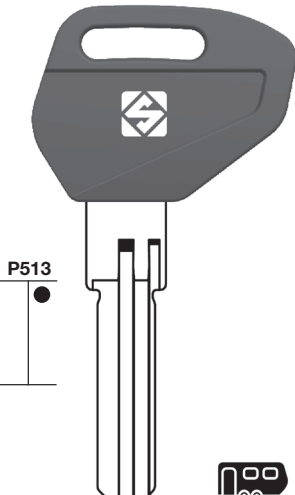
2023 NEW KEYS COLLECTION

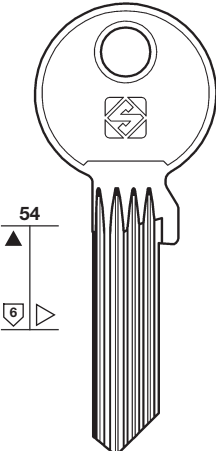
NEW KEYS

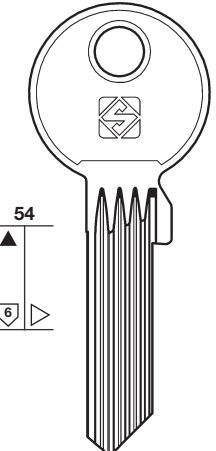

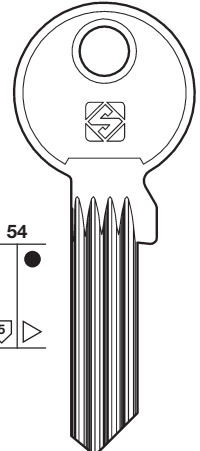
Silca key blanks are compatible with third party manufacturers' cylinders specified here below:

EMKA*	ESETY*	EURO LOCKS*	
 <p>1374</p> <p>Orig. code: C039</p>  <p>EMK4R</p>  <p>8 052782 032214</p> <p>Box of 100</p>	 <p>P514</p> <p>NEW</p>  <p>5EY35P</p>  <p>8 052782 037455</p> <p>Box of 5</p>	 <p>P513</p>  <p>EU17AP</p>  <p>8 052782 030142</p> <p>Box of 25</p>	<p>EMKA* (FR)</p> <p>ESETY* (IT)</p> <p>EURO LOCKS* (BE)</p> <p>EVVA* (AT)</p>
EVVA*			
 <p>54</p> <p>6</p>  <p>EV135X</p>  <p>8 052782 034041</p> <p>Box of 50</p>	 <p>54</p> <p>6</p>  <p>EV135RX</p>  <p>8 052782 034058</p> <p>Box of 50</p>	 <p>54</p> <p>5</p>  <p>EV104X</p> <p>GPI Serie</p>  <p>8 003737 858403</p> <p>Box of 50</p>	<p>(*) This is a trademark of a third party not affiliated nor linked with Silca S.p.A. or the dormakaba Group. Silca S.p.A. and dormakaba Group do not own any intellectual property right nor have been granted any license with regard to such trademark, which is hereby used only to indicate the intended purpose of Silca's products.</p>











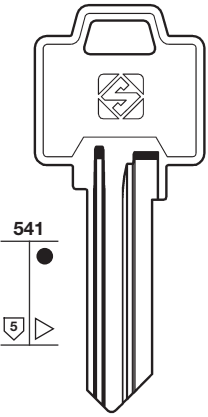

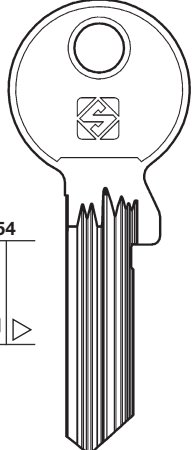

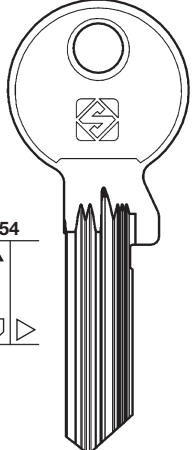

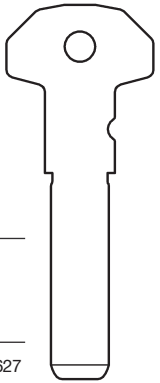

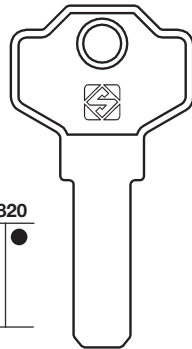
2023 NEW KEYS COLLECTION

NEW KEYS

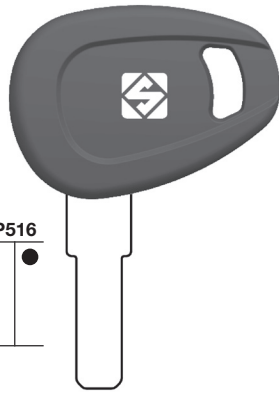

Silca key blanks are compatible with third party manufacturers' cylinders specified here below:

FALCON*	GEGE*		FALCON* (US)
 <p>541</p>  <p>FN7</p>  <p>8 052782 034775</p> <p>Box of 100</p>	 <p>54</p>  <p>GE178RX-18</p>  <p>8 052782 036342</p> <p>Box of 50</p>	 <p>54</p>  <p>GE178RX-19</p>  <p>8 052782 036359</p> <p>Box of 50</p>	<p>FALCON* (US)</p>
 <p>S1627</p> <p>DE 1-11210</p>  <p>GT21T</p>  <p>8 052782 035680</p> <p>Bag of 1</p>	 <p>1820</p>  <p>GS18</p>   <p>8 052782 031613</p> <p>Box of 100</p>	 <p>P516</p>  <p>GIV1P</p>   <p>8 052782 033587</p> <p>Box of 25</p>	<p>GEGE* (AT)</p> <p>GIOBERT* (IT)</p> <p>GIUSSANI* (IT)</p>
			<p>GIVI* (IT)</p>
<p>(*) This is a trademark of a third party not affiliated nor linked with Silca S.p.A. or the dormakaba Group. Silca S.p.A. and dormakaba Group do not own any intellectual property right nor have been granted any license with regard to such trademark, which is hereby used only to indicate the intended purpose of Silca's products.</p>			











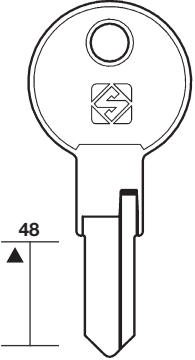

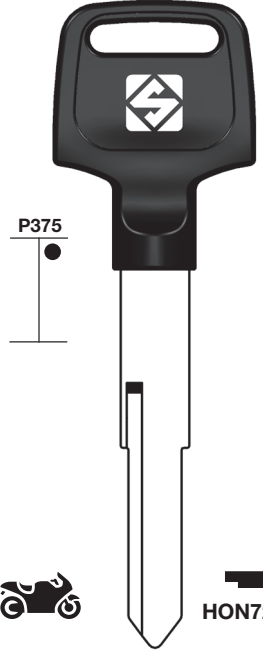



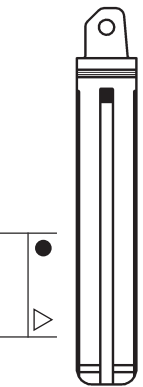

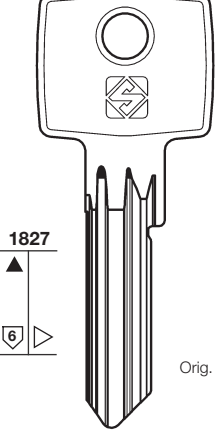

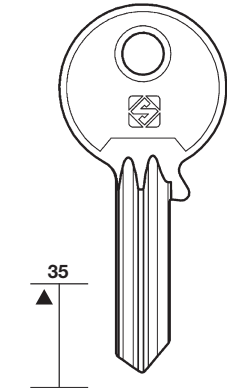
2023 NEW KEYS COLLECTION

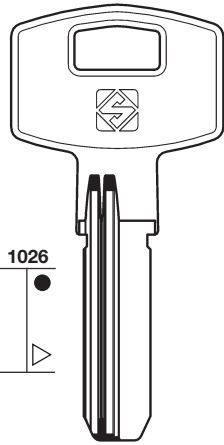
NEW KEYS

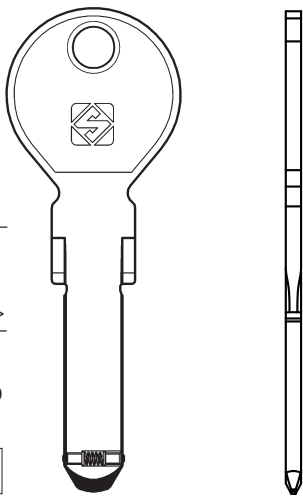

Silca key blanks are compatible with third party manufacturers' cylinders specified here below:

GTV*	HONDA*	HYUNDAI*	ISEO*	GTV* (DE)			
 <p>48</p>  <p>GV22</p>  <p>8 052782 036373</p> <p>Box of 100</p>	 <p>P375</p>   <p>HON72RP</p>  <p>8 052782 029672</p> <p>Box of 25</p>	  <p>HYN20T</p>  <p>8 052782 034720</p> <p>Box of 50</p>	 <p>1827</p>  <p>F6 IE39</p> <p>Orig. code: F6</p>  <p>8 052782 029627</p> <p>Box of 50</p>	HONDA* (JP)			
 <p>35</p>  <p>JU18</p>  <p>8 052782 036977</p> <p>Box of 100</p>	 <p>1026</p>  <p>KLE12R</p>  <p>8 052782 030937</p> <p>Box of 50</p>	 <p>1318</p>  <p>Lock Systems: 2000S Omega</p> <p>S277 S673 S1299</p>  <p>KE19SM2</p> <p>Shoulder milling view</p>  <p>8 052782 032962</p> <p>Box of 50</p>	HYUNDAI* (KR)	ISEO* (IT)	JUNIE* (DE)	KALE* (TR)	KESO* (CH)

(*) This is a trademark of a third party not affiliated nor linked with Silca S.p.A. or the dormakaba Group. Silca S.p.A. and dormakaba Group do not own any intellectual property right nor have been granted any license with regard to such trademark, which is hereby used only to indicate the intended purpose of Silca's products.

Silca key blanks are compatible with third party manufacturers' cylinders specified here below:

KESO*

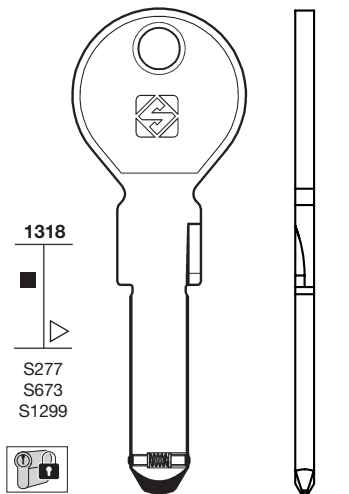

Lock Systems:
2000S Omega

Shoulder
milling view

KE19SMD



8 052782 032979
Box of 50

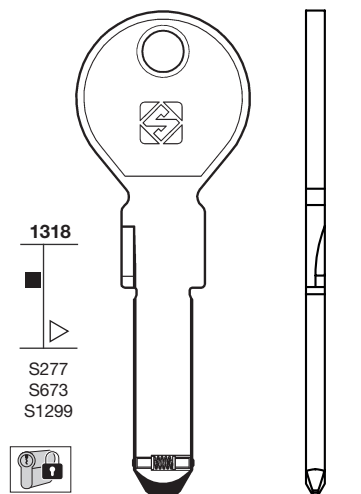

Lock Systems:
2000S Omega

Shoulder
milling view

KE19SMS



8 052782 032955
Box of 50

KESO*

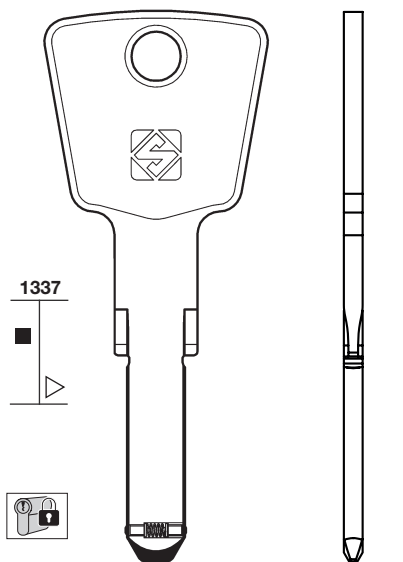

Lock Systems:
2000S Omega

Shoulder
milling view

KE20SM2



8 052782 032986
Box of 50

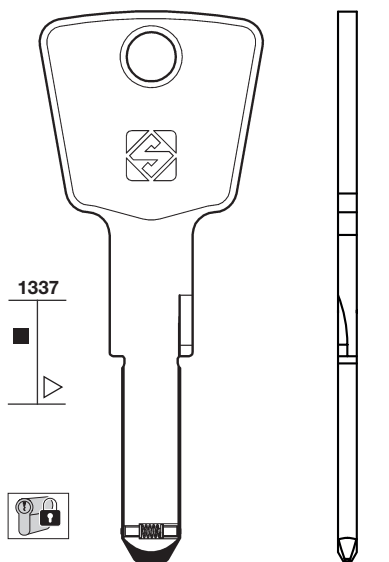

Lock Systems:
2000S Omega

Shoulder
milling view

KE20SMD



8 052782 032993
Box of 50

KESO*(CH)

(*) This is a trademark of a third party not affiliated nor linked with Silca S.p.A. or the dormakaba Group. Silca S.p.A. and dormakaba Group do not own any intellectual property right nor have been granted any license with regard to such trademark, which is hereby used only to indicate the intended purpose of Silca's products.



2023 NEW KEYS COLLECTION

NEW KEYS



Silca key blanks are compatible with third party manufacturers' cylinders specified here below:

KESO*		LIPS*		LOCKWOOD*		MAZDA*		MEC*		MERONI*			
<p>1337</p> <p>Lock Systems: 2000S Omega</p> <p>KE20SMS</p> <p>Shoulder milling view</p> <p>8 052782 033105</p> <p>Box of 50</p>		<p>1047</p> <p>LP59</p> <p>8 052782 028453</p> <p>Box of 50</p>		<p>1047</p> <p>LP59R</p> <p>8 052782 034409</p> <p>Box of 50</p>		<p>614</p> <p>LW35</p> <p>8 052782 037943</p> <p>Box of 100</p>		<p>10100-12283</p> <p>MAZ27R</p> <p>8 052782 035659</p> <p>Bag of 1</p>		<p>1830</p> <p>MCE1</p> <p>8 052782 029870</p> <p>Box of 50</p>		<p>1829</p> <p>MER46R</p> <p>8 052782 029849</p> <p>Box of 100</p>	
										<p>(*) This is a trademark of a third party not affiliated nor linked with Silca S.p.A. or the dormakaba Group. Silca S.p.A. and dormakaba Group do not own any intellectual property right nor have been granted any license with regard to such trademark, which is hereby used only to indicate the intended purpose of Silca's products.</p>			











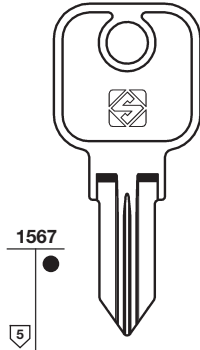

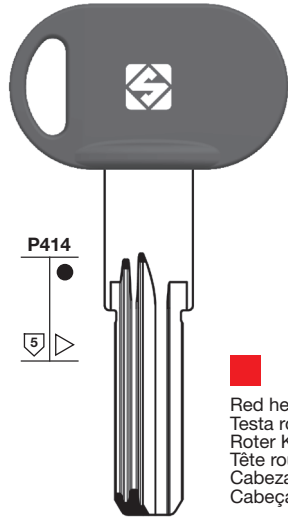

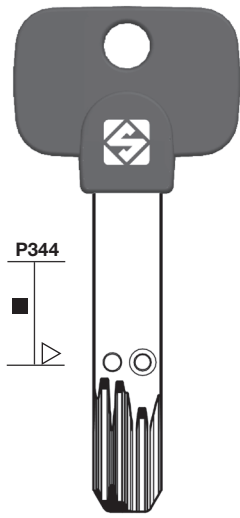
2023 NEW KEYS COLLECTION

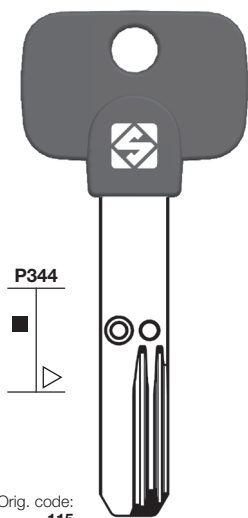
NEW KEYS

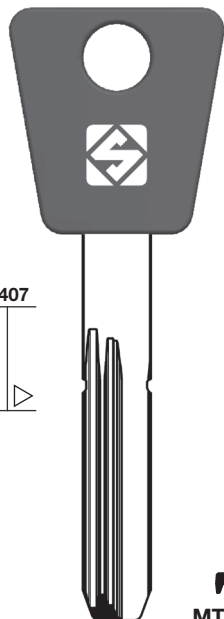

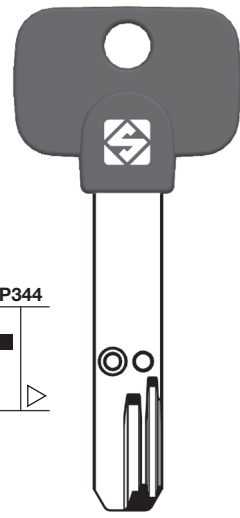
Silca key blanks are compatible with third party manufacturers' cylinders specified here below:

MLM*	MOTTURA*		
 <p>1567</p>  <p>MLM14</p> <p>FEBRU</p>  <p>8 052782 032870</p> <p>Box of 50</p>	 <p>P414</p>  <p>MT10RAP</p>  <p>8 052782 035673</p> <p>Box of 25</p> <p>Red head Testa rossa Roter Kopf Tête rouge Cabeza roja Cabeça ruiva</p>	 <p>P344</p>  <p>MTK21RP</p>  <p>8 052782 029689</p> <p>Box of 25</p>	<p>MLM* (DE)</p> <p>MOTTURA* (IL)</p> <p>MUL.T.LOCK* (IL)</p>
MUL.T.LOCK*			
 <p>P344</p>  <p>Orig. code: 115</p> <p>MTK24P</p>  <p>8 052782 036380</p> <p>Box of 25</p>	 <p>P407</p>  <p>MTK22RAP</p>  <p>8 052782 035208</p> <p>Box of 25</p>	 <p>P344</p>  <p>MTK23P</p>  <p>8 052782 035215</p> <p>Box of 25</p>	<p>(*) This is a trademark of a third party not affiliated nor linked with Silca S.p.A. or the dormakaba Group. Silca S.p.A. and dormakaba Group do not own any intellectual property right nor have been granted any license with regard to such trademark, which is hereby used only to indicate the intended purpose of Silca's products.</p>

Silca key blanks are compatible with third party manufacturers' cylinders specified here below:

NEMEF*	NETHERLAND*	
 1549 NME8 Box of 50	 $\varnothing 5,4$ 667 A 14 mm 19,8 mm 6NTH-1 Box of 25	 $\varnothing 5,9$ 667 A 14 mm 20,35 mm 6NTH-2 Box of 25

NETHERLAND*	
 $\varnothing 6,4$ 667 A 14 mm 20,75 mm 6NTH-3 Box of 25	 $\varnothing 6,9$ 667 A 14 mm 21,25 mm 6NTH-4 Box of 25

NEMEF* (FR)
NETHERLAND* (NL)

(*) This is a trademark of a third party not affiliated nor linked with Silca S.p.A. or the dormakaba Group. Silca S.p.A. and dormakaba Group do not own any intellectual property right nor have been granted any license with regard to such trademark, which is hereby used only to indicate the intended purpose of Silca's products.











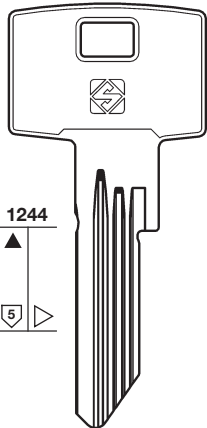

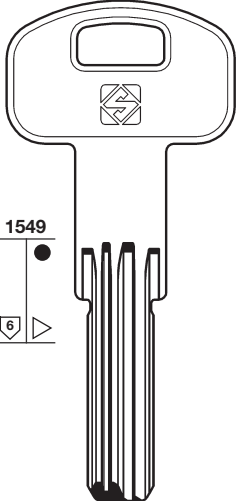

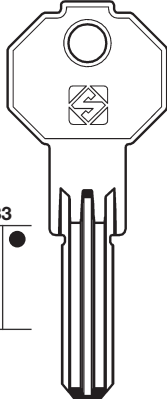
2023 NEW KEYS COLLECTION

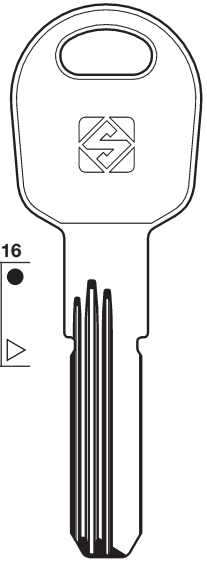

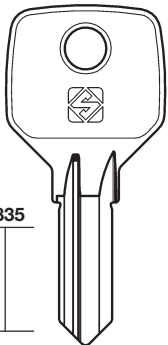

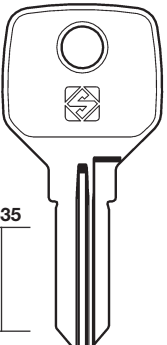



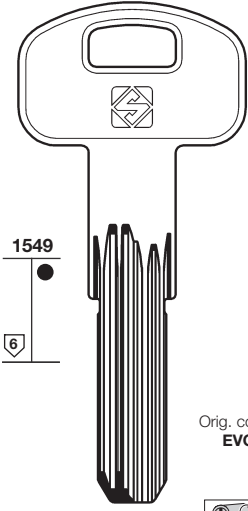

NEW KEYS

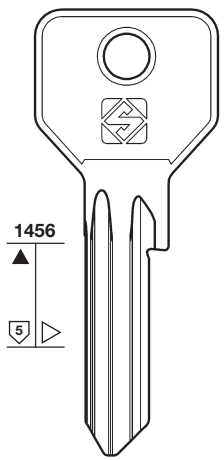

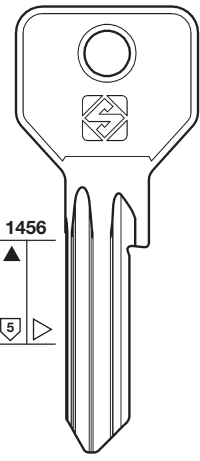
Silca key blanks are compatible with third party manufacturers' cylinders specified here below:

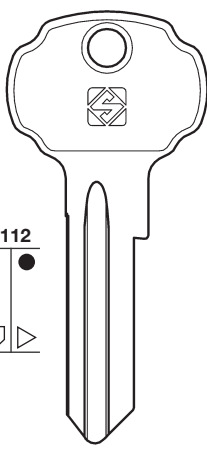
PFAFFENHAIN*	POTENT*	PREFER*	
 <p>1244 5</p>  <p>PHF51R</p>  <p>8 052782 036984</p> <p>Box of 50</p>	 <p>1549 6</p>  <p>PT7R</p>  <p>8 052782 037936</p> <p>Box of 50</p>	 <p>33 5</p>  <p>PF23</p>  <p>8 052782 035536</p> <p>Box of 50</p>	<p>PFAFFENHAIN* (DE)</p> <p>POTENT* (IT)</p> <p>PREFER* (IT)</p> <p>ROBIWANG* (RC)</p> <p>RONIS* (FR)</p>
ROBIWANG*	RONIS*		<p>(*) This is a trademark of a third party not affiliated nor linked with Silca S.p.A. or the dormakaba Group. Silca S.p.A. and dormakaba Group do not own any intellectual property right nor have been granted any license with regard to such trademark, which is hereby used only to indicate the intended purpose of Silca's products.</p>
 <p>1716</p>  <p>ROW1R</p>  <p>8 052782 033556</p> <p>Box of 50</p>	 <p>1835</p>  <p>RO87</p>  <p>8 052782 037097</p> <p>Box of 100</p>	 <p>1835</p>  <p>RO88</p>  <p>8 052782 034775</p> <p>Box of 100</p>	

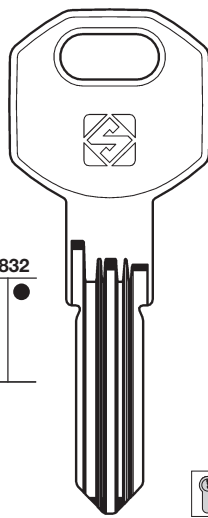
Silca key blanks are compatible with third party manufacturers' cylinders specified here below:

SECUREMME*	STUBLINA*		SECUREMME* (IT) STUBLINA* (RS) THIRARD* (FR) TILANCO* (IT)
 <p>1549</p> <p>6</p> <p>Orig. code: EVOK1</p>  <p>SCM5R</p>  <p>8 052782 033044</p> <p>Box of 50</p>	 <p>NEW</p> <p>1456</p> <p>5</p>  <p>STN2</p>  <p>8 052782 039701</p> <p>Box of 50</p>	 <p>NEW</p> <p>1456</p> <p>5</p>  <p>STN2R</p>  <p>8 052782 039718</p> <p>Box of 50</p>	<p>(*) This is a trademark of a third party not affiliated nor linked with Silca S.p.A. or the dormakaba Group. Silca S.p.A. and dormakaba Group do not own any intellectual property right nor have been granted any license with regard to such trademark, which is hereby used only to indicate the intended purpose of Silca's products.</p>
 <p>NEW</p> <p>1112</p> <p>10</p>  <p>THR4R</p>  <p>8 052782 036670</p> <p>Box of 50</p>	 <p>1832</p>  <p>TLC3</p>  <p>8 052782 029863</p> <p>Box of 50</p>		



2023 NEW KEYS COLLECTION

NEW KEYS



Silca key blanks are compatible with third party manufacturers' cylinders specified here below:

TILANCO*



P518



TLC1RP



P518



TLC2RP



P518



TLC4RP

HERACLES - YARDENI



Box of 25



Box of 25



Box of 25

TITAN*

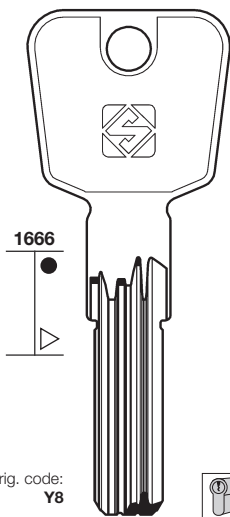

1666



Orig. code: Y8



TN57



Box of 50

TOK-WINKHAUS*

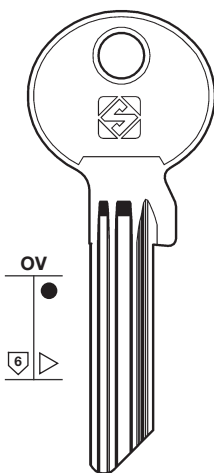

OV



X/Y Profile

TO126X



Box of 50

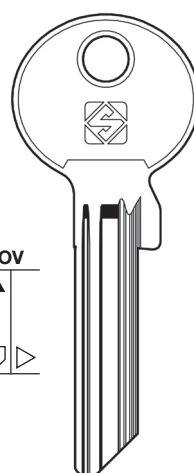

OV



X/Y Profile

TO126RX



Box of 50

TILANCO* (IT)

TITAN* (SI)

TOK-WINKHAUS* (DE)

(*) This is a trademark of a third party not affiliated nor linked with Silca S.p.A. or the dormakaba Group. Silca S.p.A. and dormakaba Group do not own any intellectual property right nor have been granted any license with regard to such trademark, which is hereby used only to indicate the intended purpose of Silca's products.











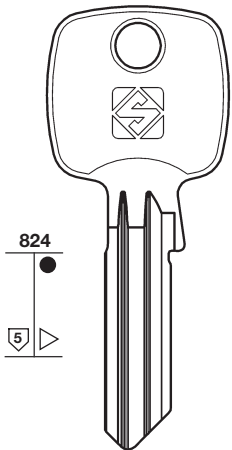

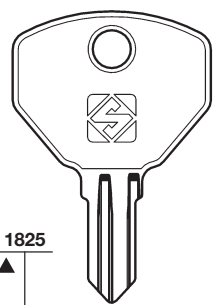

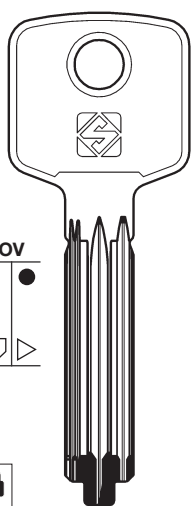
2023 NEW KEYS COLLECTION

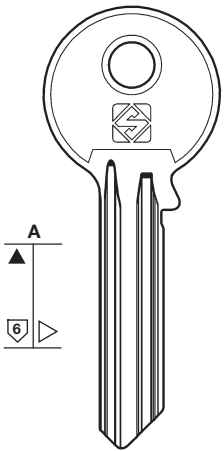
NEW KEYS

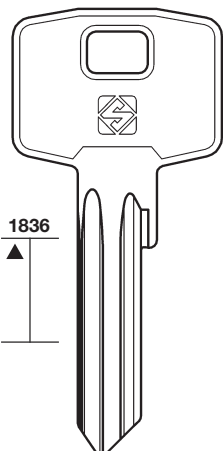

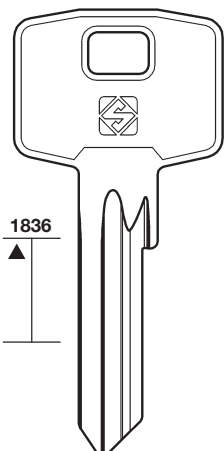
Silca key blanks are compatible with third party manufacturers' cylinders specified here below:

TOK-WINKHAUS*	TORK*	ULTION*	
 <p>824</p> <p>5</p>  <p>TO134X</p>  <p>8 052782 030883</p> <p>Box of 50</p>	 <p>1825</p> <p>3</p>  <p>TOR1</p>  <p>8 052782 029610</p> <p>Box of 100</p>	 <p>OV</p> <p>6</p>  <p>ULT1</p>  <p>8 052782 027630</p> <p>Box of 50</p>	<p>TOK-WINKHAUS* (DE)</p> <p>TORK* (FR)</p> <p>ULTION* (EN)</p> <p>UNION* (GB)</p> <p>UNIVERSAL</p>
UNION*	UNIVERSAL*		<p>(*) This is a trademark of a third party not affiliated nor linked with Silca S.p.A. or the dormakaba Group. Silca S.p.A. and dormakaba Group do not own any intellectual property right nor have been granted any license with regard to such trademark, which is hereby used only to indicate the intended purpose of Silca's products.</p>
 <p>A</p> <p>6</p> <p>Orig. code: 112A</p>  <p>UNI69SM</p>  <p>8 052782 035888</p> <p>Box of 100</p> <p>Shoulder milling view</p>	 <p>1836</p> <p>NEW</p>  <p>UL050DD</p>  <p>8 052782 037189</p> <p>Box of 100</p>  <p>1836</p> <p>NEW</p>  <p>UL051DD</p>  <p>8 052782 037196</p> <p>Box of 100</p>		



2023 NEW KEYS COLLECTION

NEW KEYS



Silca key blanks are compatible with third party manufacturers' cylinders specified here below:

VACHETTE*

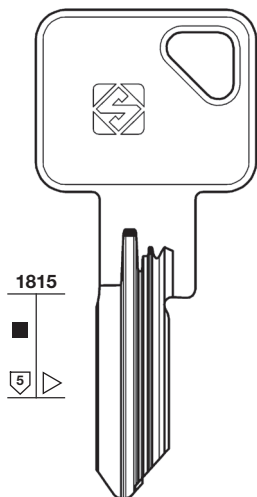

1815
■
5 ▷



VAC158



8 052782 033662
Box of 50

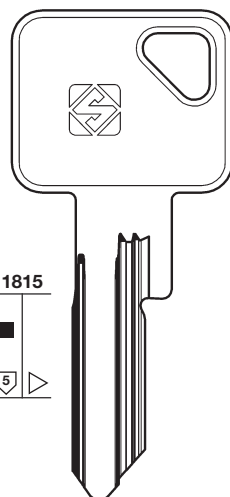

1815
■
5 ▷



VAC159



8 052782 033655
Box of 50

VACHETTE* (FR)

WANGTONG* (CN)

WILKA* (FR)

WANGTONG*

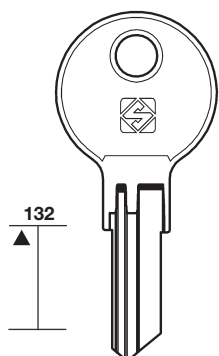

132
▲

WAN1



8 052782 036410
Box of 100

WILKA*

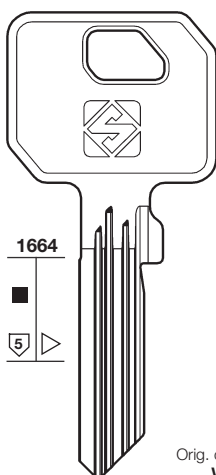

1664
■
5 ▷

Orig. code:
W235

WK88



8 052782 030135
Box of 50

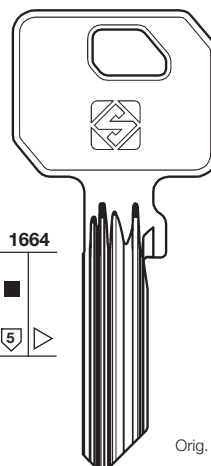

1664
■
5 ▷

Orig. code:
ZL53

WK101R



8 052782 030111
Box of 50

(*) This is a trademark of a third party not affiliated nor linked with Silca S.p.A. or the dormakaba Group. Silca S.p.A. and dormakaba Group do not own any intellectual property right nor have been granted any license with regard to such trademark, which is hereby used only to indicate the intended purpose of Silca's products.



2023 NEW KEYS COLLECTION

NEW KEYS



Silca key blanks are compatible with third party manufacturers' cylinders specified here below:

WILKA*			WILKA* (FR)
			YALE* (IT)
OV ▲ 5 ▷	OV ▲ 5 ▷	OV ▲ 5 ▷	
WK103RX-1	WK103RX-2	WK103RX-3	
Box of 100	Box of 100	Box of 100	
YALE*			
1584 ▲ ● 6 ▷	1584 ● 6 ▷ S1345	1584 ● 6 ▷ S1345	
Lock System: 62000 Series	Lock System: 1000 Series	Lock System: 1000 Series	
YA91SM	YA94SMD	YA94SMD	
Box of 50 - Steel	Box of 50 - Brass	Box of 50	
	Shoulder milling view	Shoulder milling view	

(*) This is a trademark of a third party not affiliated nor linked with Silca S.p.A. or the dormakaba Group. Silca S.p.A. and dormakaba Group do not own any intellectual property right nor have been granted any license with regard to such trademark, which is hereby used only to indicate the intended purpose of Silca's products.



2023 NEW KEYS COLLECTION

NEW KEYS



Silca key blanks are compatible with third party manufacturers' cylinders specified here below:

YALE*

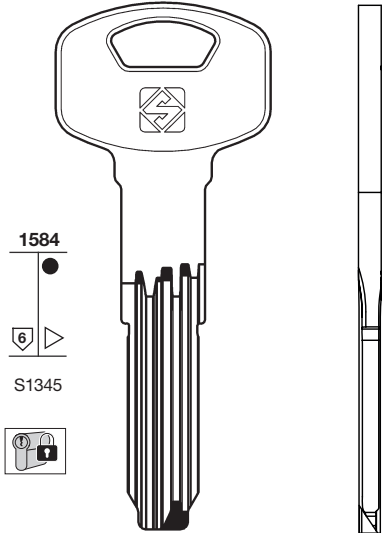

1584
6
S1345



YA115SMD



8 052782 032931

Box of 50

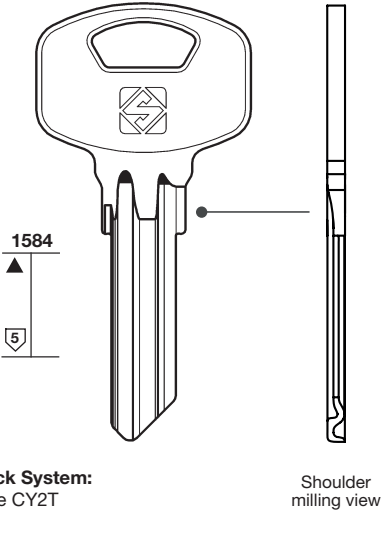

1584
5

Lock System:
Yale CY2T



YA89SM



8 052782 032887

Box of 50

YAMAHA*

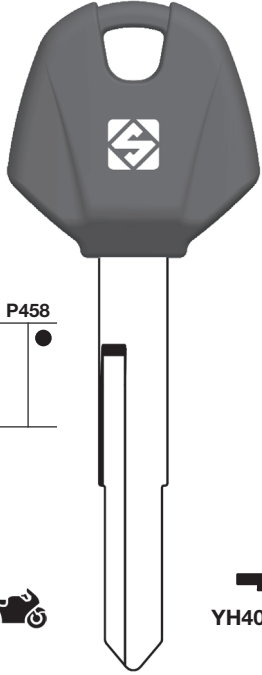

P458



YH40RATE



8 052782 034737

Bag of 5

ZEISS-IKON*

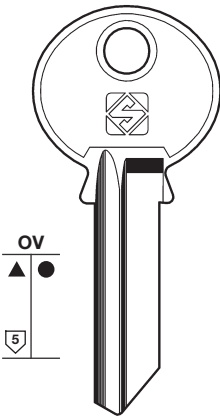

OV
5



ZE6



8 003736 249356

Box of 50 - Brass



8 003736 574076

Box of 50 - Steel

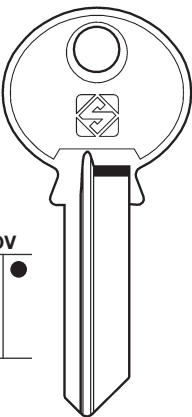

OV
5



ZE6R



8 003736 249363

Box of 50 - Brass



8 003736 574090

Box of 50 - Steel

YALE* (IT)

YAMAHA* (JP)

ZEISS-IKON* (DE)

(*) This is a trademark of a third party not affiliated nor linked with Silca S.p.A. or the dormakaba Group. Silca S.p.A. and dormakaba Group do not own any intellectual property right nor have been granted any license with regard to such trademark, which is hereby used only to indicate the intended purpose of Silca's products.



2023 NEW KEYS COLLECTION

NEW KEYS



Silca key blanks are compatible with third party manufacturers' cylinders specified here below:

ZEISS IKON*

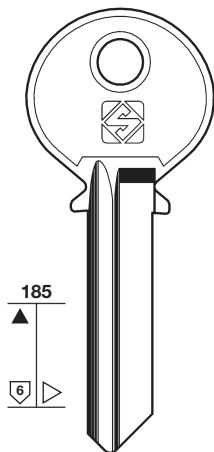

ZE6L



Box of 50

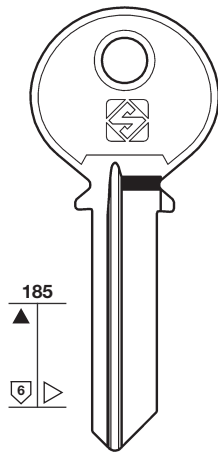

ZE6RL



Box of 50

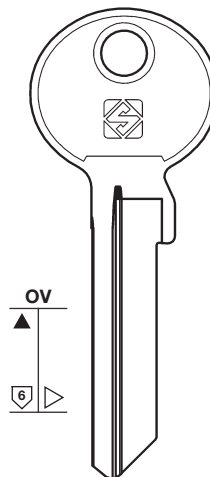

ZE66RX



Box of 50

ZEISS-IKON* (DE)

(*) This is a trademark of a third party not affiliated nor linked with Silca S.p.A. or the dormakaba Group. Silca S.p.A. and dormakaba Group do not own any intellectual property right nor have been granted any license with regard to such trademark, which is hereby used only to indicate the intended purpose of Silca's products.